

Allgemeines

Artikelnummer	950 000 0377
Produktname	ZUB ABS
Produktlinie	Zubehör
Art	Abluftset

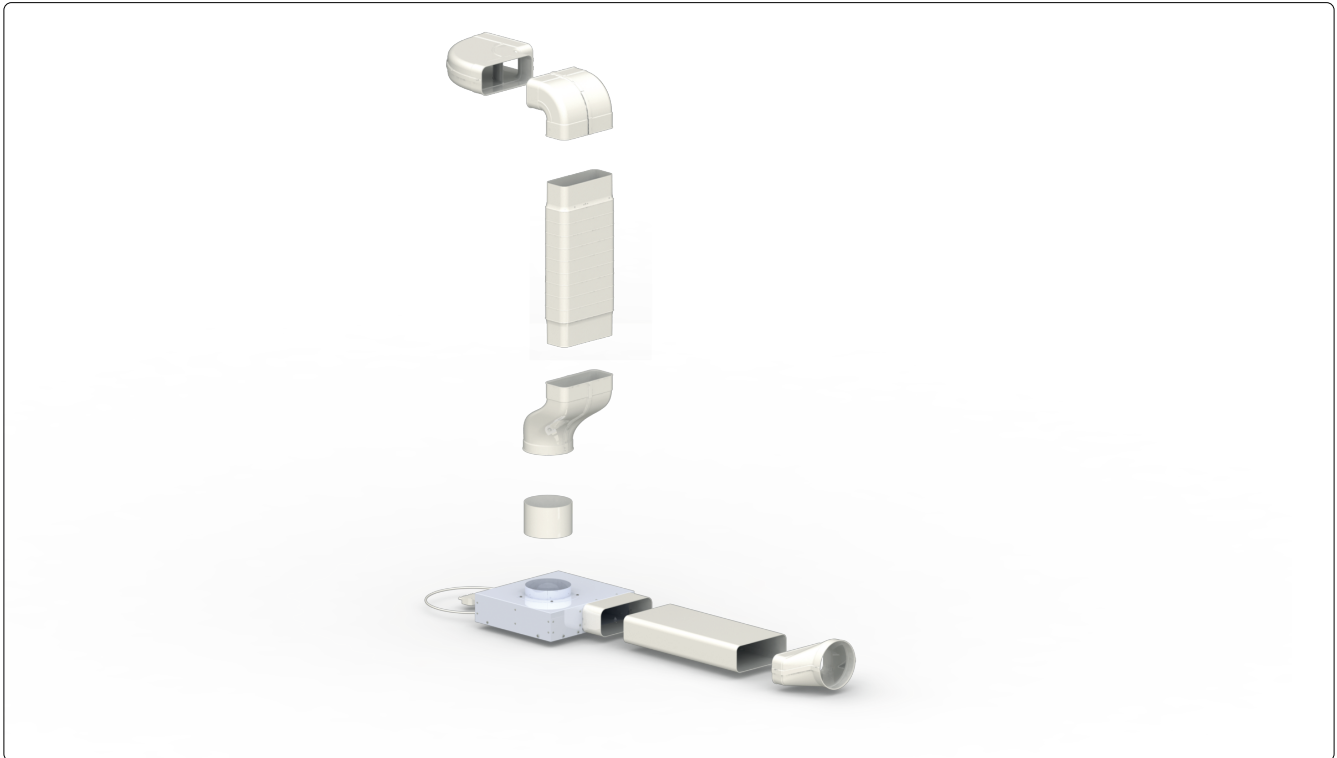

Flachkanalrohr Bogen waagrecht 90°

Artikelnummer	950 000 0145
Maße (B×H×T)	304 × 97 × 304 mm

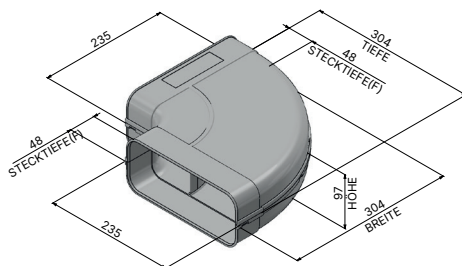

Flachkanalrohr Bogen senkrecht 90°

Artikelnummer	950 000 0146
Maße (B×H×T)	304 × 97 × 304 mm

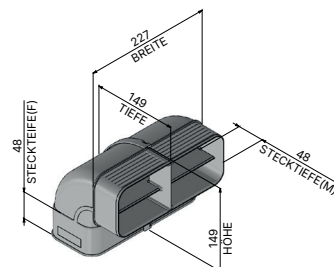

Flexschlauch

Artikelnummer	950 000 0235
Maße (B×H×T)	242 × 599 × 104 mm

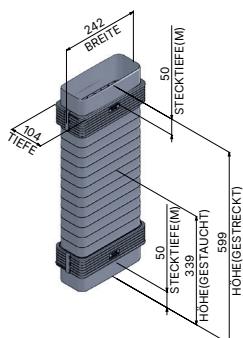

Übergangstück versetzt

Artikelnummer	950 000 0148
Maße (B×H×T)	230 × 255 × 271 mm
Durchmesser (Ø)	160 mm

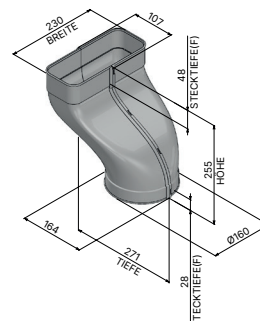

Flachkanalrohr

Artikelnummer	950 000 0158
Maße (B×H×T)	222 × 500 × 89 mm
Durchmesser (Ø)	152 mm

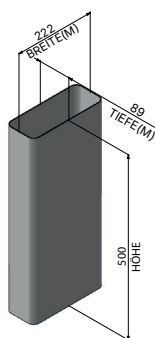

Rundrohr

Artikelnummer	9500000086
Durchmesser (Ø)	152 mm
Länge	100 mm

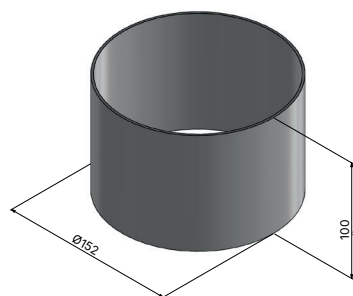

Sockelmotor

Artikelnummer	120 630 0000
Maße (B×H×T)	370 × 125,2 × 386 mm
Durchmesser (Ø)	152 mm

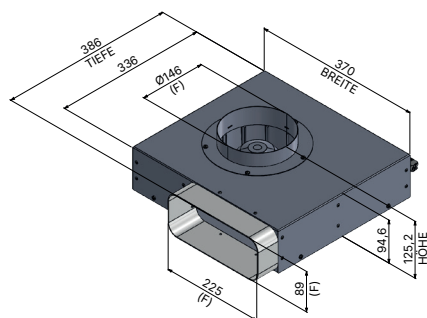

Übergangstück

Artikelnummer	950 000 0162
Maße (B×H×T)	235 × 175 × 159 mm
Durchmesser (Ø)	160 mm

